

Diritti riservati All rights reserved

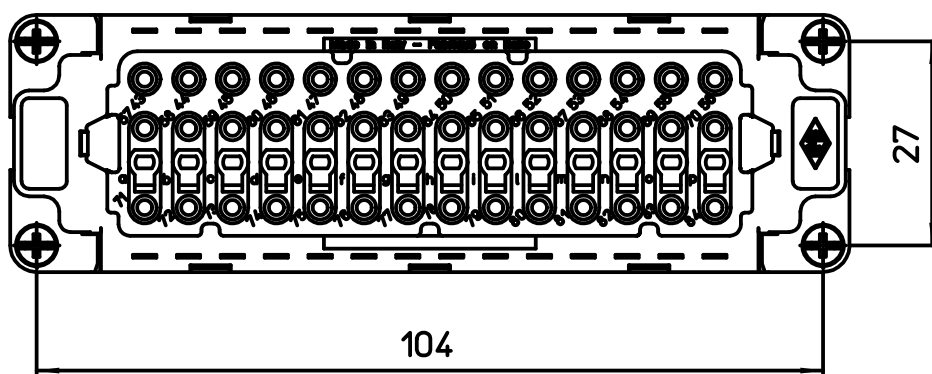
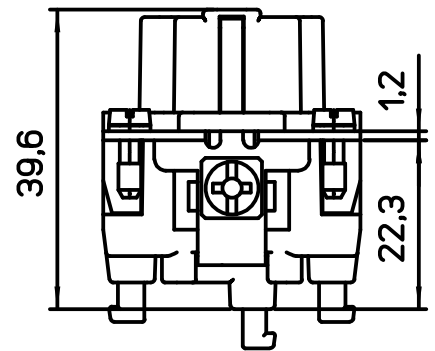
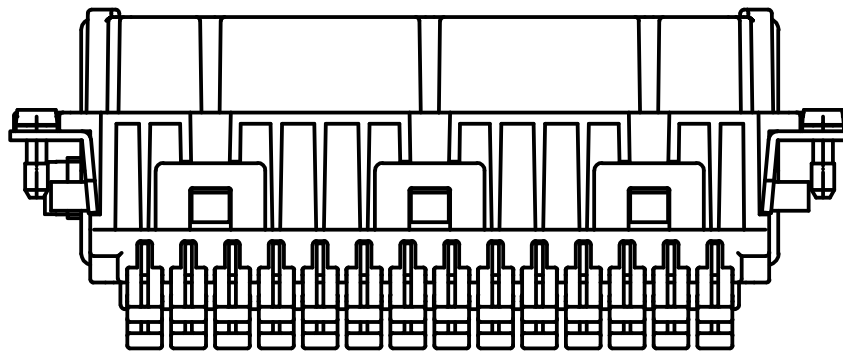
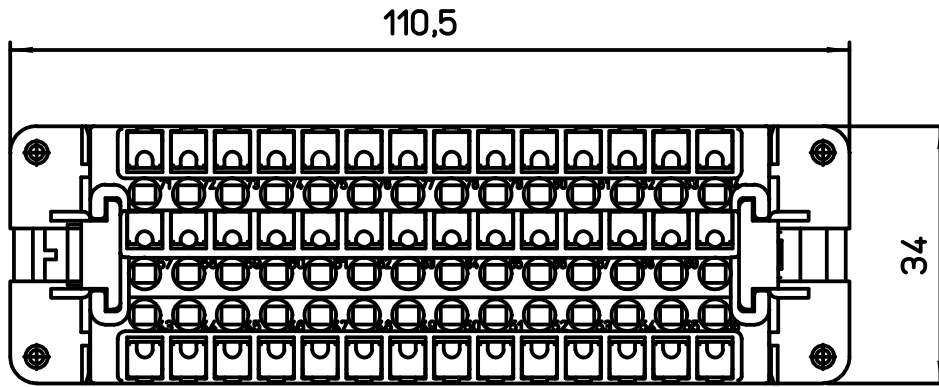
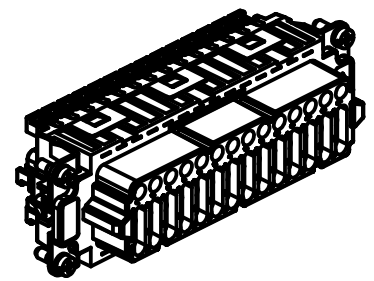

dimensions in mm	CDSHF 42 N	Scale	
Date 23/06/16	SQUICH female insert, spring, 42P 10A 400V	1:1	
Sign. D. Bonino			